

# Tire Care & Safety



**RUBBER**  
manufacturers  
association

**be tire smart**  
**play your PART**  
PRESSURE • ALIGNMENT • ROTATION • TREAD



# TABLE OF CONTENTS

---

## **BASIC TIRE INFORMATION**

- 3 Proper Tire Size, Type and Load Capacity (or Load Range)
- 3 Tire Size Designations
- 4 The Sidewall Story
- 7 Speed Symbol
- 8 Uniform Tire Quality Grading (UTQG) Standards

## **PROPER TIRE INFLATION AND VEHICLE LOADING**

- 9 Proper Inflation is Critical
- 11 When to Check Inflation Pressure
- 11 Continuous Inflation Pressure Loss
- 12 Additional Tire Pressure Recommendations
- 13 Proper Tire Loading

## **REGULAR TIRE ROTATION**

- 14 Rotation Patterns

## **REGULAR TIRE INSPECTION**

- 16 Tire Inspection Guidelines
- 18 Tire Service Life

## **PROPER TIRE REPAIR**

- 19 Have Your Tire Repaired Properly
- 20 Vehicle Original Equipment Temporary Tire Mobility Kits
- 21 Aftermarket Sealants

## **VEHICLE CONDITION, ALIGNMENT AND MAINTENANCE**

- 22 Abnormal Mechanical Conditions
- 23 Additional Conditions Affecting Tread Wear
- 24 Spare Tire Maintenance
- 24 Tire Storage Recommendations
- 25 Cleaning Tires

## **GOOD DRIVING HABITS**

- 26 Road Hazard and Impact Damage
- 27 Sudden Vibration or Ride Disturbance
- 27 Tire Spinning
- 27 Wet Weather Driving
- 28 Winter/Snow Conditions

## **TIRE REPLACEMENT GUIDELINES**

- 30 The Right Tire for the Vehicle
- 31 Self-Supporting Runflat Tires
- 31 Tire Mixing
- 32 Replacing Less Than Four Tires
- 32 Used Tires

# Tire Care and Safety

This booklet provides an understanding of the many factors essential to the proper care and service of passenger and light truck tires. This booklet is not all inclusive. Questions pertaining to specific products and/or vehicle fitments should be addressed to the vehicle manufacturer, tire manufacturer or tire dealer.

## **TIRE INFORMATION AND SERVICE ASSISTANCE**

When you have a question about tires, there are various sources of information available. The Rubber Manufacturers Association's website, [www.rma.org](http://www.rma.org), provides information on tire care and safety and publications for consumers. The National Highway Traffic Safety Administration's website, [www.safercar.gov](http://www.safercar.gov) has a wide range of tire related information including information on tire labeling, tire ratings, and tire maintenance. Also, tire manufacturer's and tire retailer's websites will often contain a considerable amount of helpful tire information.

### **The Most Important Factors in Tire Safety, Performance and Service Life are:**

- Proper Tire Size, Type and Load Capacity (or Load Range)
- Proper Inflation Pressure
- Proper Vehicle Loading
- Regular Tire Rotation
- Regular Inspection
- Proper Tire Repair
- Vehicle Condition, Alignment and Maintenance
- Good Driving Habits

Your local tire retailer, who has specialized tire knowledge and experience, is an excellent resource when you have a question about tires or require service assistance. Tire service professionals can provide you with proper tire service including inspection, replacement and repair.



# BASIC TIRE INFORMATION

## Proper Tire Size, Type and Load Capacity (or Load Range)

There are a large number of tires for passenger cars and light trucks intended to meet the needs of a wide variety of consumers, vehicles and operating conditions. Selecting and utilizing the proper tire starts with an understanding of the basics of tire size, type and load capacity (or load range), which is presented in this section. In addition, there is an explanation of speed ratings, determining a tire manufacture date and a guide to other information found on the sidewalls of most passenger and/or light truck tires.

## Tire Size Designations

Most passenger and light truck tires have tire size designations such as the following:

PASSENGER						
<b>P-Metric</b>		<b>P225/50R15 90H</b>				
<b>P</b>	<b>225</b>	<b>50</b>	<b>R</b>	<b>15</b>	<b>90H</b>	
P-Metric	Nominal Section Width (millimeters)	Aspect Ratio (Ratio of Section Height to Section Width)	Radial Construction	Rim Diameter Code	Service Description (Load Index & Speed Symbol)	
<b>European Metric</b>		<b>225/45R17 91H</b>				
<b>225</b>	<b>45</b>	<b>R</b>	<b>17</b>	<b>91H</b>		
Nominal Section Width (millimeters)	Aspect Ratio (Ratio of Section Height to Section Width)	Radial Construction	Rim Diameter Code	Service Description (Load Index & Speed Symbol)		
LIGHT TRUCK						
<b>LT-Metric</b>		<b>LT235/85R16 120/116Q Load Range E</b>				
<b>LT</b>	<b>235</b>	<b>85</b>	<b>R</b>	<b>16</b>	<b>120/116Q</b>	<b>E</b>
Light Truck	Nominal Section Width (millimeters)	Aspect Ratio (Ratio of Section Height to Section Width)	Radial Construction	Rim Diameter Code	Service Description (Load Index & Speed Symbol) for Single/Dual	Load Range
<b>Flotation</b>		<b>31X10.50R15LT Load Range C</b>				
<b>31</b>	<b>10.5</b>	<b>R</b>	<b>15</b>	<b>LT</b>	<b>C</b>	
Nominal Overall Diameter (inches)	Nominal Section Width (inches)	Radial Construction	Rim Diameter Code	Light Truck	Load Range	

**Aspect Ratio** - In a tire size designation, the aspect ratio is the ratio of the tire section height to section width. Aspect ratios are also referred to as “series” and “profile” numbers. In the example shown of a tire with an aspect ratio of 60, the section height of the tire is 60% of the section width. Aspect ratios typically range from 30 to 80.

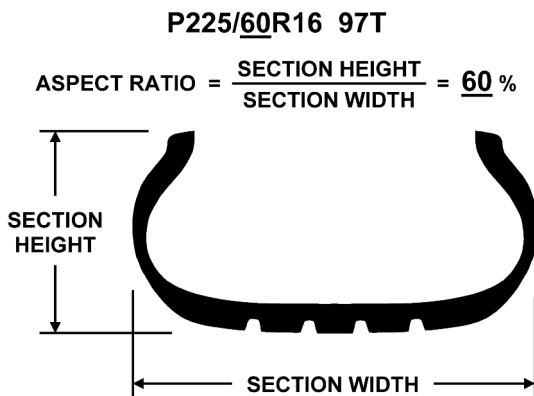

### The Sidewall Story

Tires have very useful information molded onto their sidewall. It shows the brand and model name of the tire, its size, whether it is tubeless or tube type, the maximum load and the maximum inflation, safety warning(s), and much more.

**P225/60R16 97T** – (See Passenger Tire on page 5) Size marking and service description (load index and speed symbol) for a P-Metric speed-rated passenger tire.

**LT245/75R16 120/116Q Load Range E** – (See Light Truck Tire on page 5) Size marking, service description (load index and speed symbol) and load range for a metric light truck tire. The load range identifies the tire's load and inflation limits.

**Load Index** - The load index is a numerical code associated with the maximum load a tire can carry. The load index should not be used independently to determine replacement tire acceptability for load capacity. (See page 30 for replacement tire guidelines.)

**Speed Symbol** - The speed symbol is also known as a “speed rating.” See page 7.

**Max Load 730 kg (1609 lbs) and 240 kPa (35 psi) Max Pressure Cold** – (See Passenger Tire on page 5) indicates maximum load and maximum cold inflation pressure of the tire. Sidewall markings are given in both metric and English units. Follow tire inflation pressure recommendations on the vehicle tire placard, certification label or in the owner's manual.



## Passenger Tire

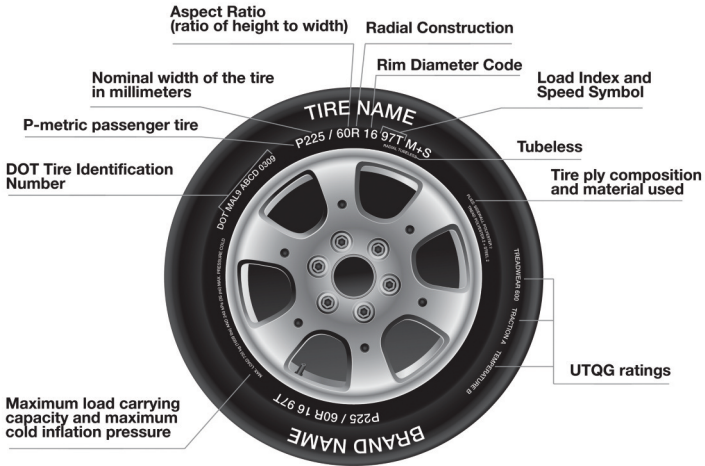

## Light Truck Tire

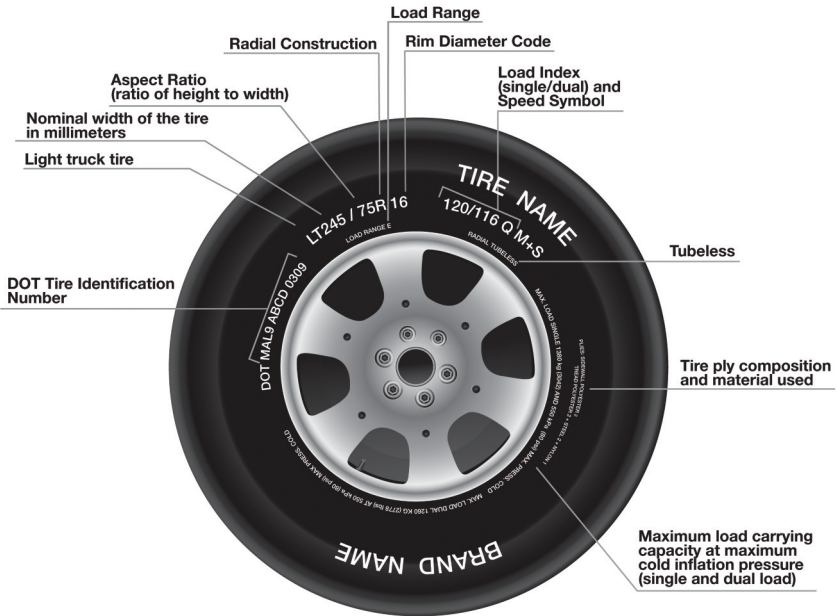

**Max Load Single 1380 kg (3042 lbs) at 550 kPa (80 psi) Max Pressure Cold**  
**Max Load Dual 1260 kg (2778 lbs) at 550 kPa (80 psi) Max Pressure Cold** – (See Light Truck Tire on page 5) indicates the maximum load of the tire and corresponding maximum cold inflation pressure for that load when used in a single or dual configuration. Sidewall markings are given in both metric and English units. Follow tire inflation pressure recommendations on the vehicle tire placard, certification label or in the owner's manual.

**DOT MA L9 ABCD 0309** - The "DOT" symbol certifies the tire manufacturer's compliance with U.S. Department of Transportation (U.S. DOT) tire safety performance standards. Next to these letters is the tire identification number (TIN) - also known as the tire "serial" number. The first two digits are the factory code indicating where the tire was made. The last four digits are numbers identifying the week and year of manufacture (Example: "0309" means third week of the year 2009.) Prior to the year 2000, the last three digits of the TIN represent the date code. (Example "025" is the second week of 1995.) For the 1990-1999 decade some tires may be marked with a symbol (such as a triangle) after the TIN date code.

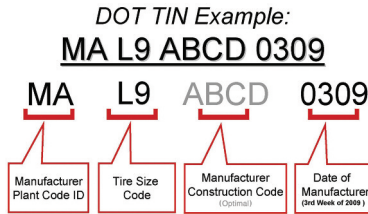

**Tread wear 600 Traction A Temperature B** – Tread wear, traction, and temperature are quality grades established and required by U.S. DOT under the Uniform Tire Quality Grading Standards (UTQG). See page 8.

**Plies/Fabric Information** - The ply/fabric information identifies the number of plies and type of cord materials in the tire tread and sidewall areas.

**Radial** - A tire with a radial construction must show the word "RADIAL" on the sidewall. A radial tire is also indicated by the character "R" in the size designation.

**Tubeless** - The tire must be marked either "tubeless" or "tube type."

**M + S** - This mark is commonly found on all-season and winter tires. In several formats, the letters "M" and "S" indicate the tire is intended for limited mud and snow service. Other formats include: "MS," "M/S," or "M&S."



**Mountain-Snowflake Symbol** - This mark is commonly found on winter/snow tires. Tires that meet the RMA definition for passenger and light truck tires for use in severe snow conditions are marked on at least one sidewall with the letters "M" and "S" (see page 6) plus the mountain snowflake symbol.



**Speed Symbol**

The speed symbol, also known as a speed rating, indicates the speed category associated with the tire’s maximum speed capability. Speed ratings are based on laboratory tests that relate to performance on the road, but are not applicable if tires are under inflated, over loaded, worn out, damaged, or altered.

Although a tire may be speed rated, RMA does not endorse the operation of any vehicle in an unsafe or unlawful manner. Furthermore, tire speed ratings do not imply that a vehicle can be safely driven at the maximum speed for which the tire is rated, particularly under adverse road and weather conditions or if the vehicle has unusual characteristics. Consult the tire manufacturer for speed capability when there is no service description or speed symbol marked on the tire.

**Speed Symbols**

	Speed Symbol	MPH	Speed Category*
			KM/H
	M	81	130
	Q	99	160
	R	106	170
	S	112	180
	T	118	190
	U	124	200
	H	130	210
	V	149	240
ZR**	W	168	270
	Y	186	300
	(Y)	>186	>300

\* In standardized laboratory tests that relate to highway speeds. Actual tire speed and performance capability depend on factors such as inflation pressure, load, tire condition, wear, and driving conditions.

\*\* Any tire having a maximum speed capability above 149 mph (240 km/h) may, at the tire manufacturer’s discretion, include a "Z" in the size designation (i.e. P275/40ZR17). For tires having a maximum speed capability above 186 mph (300 km/h), a "Z" must appear in the size designation and must include a service description with a "(Y)."

Consult the tire manufacturer for speed capability when there is no service description or speed symbol marked on the tire.

- Examples:
- P275/40ZR17 max speed > 149 mph - consult tire mfr.
  - P275/40R17 93W max speed = 168 mph
  - P275/40ZR17 93W max speed = 168 mph
  - P275/40ZR17 93Y max speed = 186 mph
  - P275/40ZR17 (93Y) max speed > 186 mph - consult tire mfr.

## Uniform Tire Quality Grading (UTQG) Standards

The National Highway Traffic Safety Administration (NHTSA) established the Uniform Tire Quality Grading Standards as a way to assist the consumer to compare various tires. UTQG applies to the vast majority of passenger car tires (excluding tires such as winter-type snow tires). NHTSA sets the standards that rate the relative performance of tires based on three criteria: tread wear, traction and temperature. The grades are molded on the tire sidewall. Replacement tires also have a label affixed to the tread that lists and explains these grades. A vehicle's engine type, transmission type, gear ratios, driving styles, road surface, inflation pressure, and other factors can affect actual performance of the tire from one vehicle to another.



The UTQG tire characteristics are as follows:

**Tread wear** - The tread wear grade is a comparative rating based on the wear rate of the tire when tested under controlled conditions on a specified government test course. In the example shown, the tread wear grade is 600, which means it would wear twice as well on the government course as a tire graded 300. The relative performance of tires depends upon the actual conditions of their use and may depart significantly from the norm due to variations in driving habits, service practices and differences in road characteristics and climate.

**Traction** - The traction grades, from highest to lowest, are AA, A, B, and C and they represent the tire's ability to stop on wet pavement as measured under controlled conditions on specified government test surfaces of asphalt and concrete. The traction grade assigned is based on braking (straight ahead) traction tests and does not include cornering (turning) traction.

**Temperature** - The temperature grades are A (the highest), B and C, representing the tire's resistance to the generation of heat and its ability to dissipate heat when tested under controlled conditions on a specified indoor laboratory test wheel. The temperature grade is established for a tire that is properly inflated and not overloaded. Excessive speed, under inflation, or overloading, either separately or in combination, can cause heat buildup which may result in tire damage and/or tire failure.



In addition to the UTQG standards, all passenger car tires must conform to federal performance safety requirements.

# PROPER TIRE INFLATION AND VEHICLE LOADING

The recommended inflation pressures for tires are specified in PSI (pounds per square inch) or kPa (kilopascals) as indicated on the vehicle tire placard, certification label or in the owner's manual. Never set tire inflation pressures below the recommended inflation pressure found on the vehicle tire placard, certification label or owner's manual. Under inflation causes excessive heat build-up and internal structural damage that may lead to a tire failure, including tread/belt separation, even at a later date. Do not exceed the maximum inflation pressure shown on the tire sidewall. Over inflated tires (over the maximum molded on the tire sidewall) are more likely to be cut, punctured or damaged by sudden impact from hitting an obstacle, such as a pothole.

**Example of a Vehicle Tire Placard**

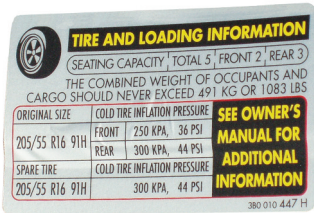

**Example of a Vehicle Certification Label**



## Proper Inflation is Critical

Inflation pressure enables a tire to support the load and to control the vehicle, therefore proper inflation is critical. With the right amount of inflation pressure, the vehicle and the tires will achieve their optimum performance. In addition to tire safety, this means your tires will wear longer and improve vehicle fuel consumption. Note that some vehicles may have different cold inflation pressures for tires on the front and rear axles.

# WARNING

Driving on tires with improper inflation pressure is dangerous.

- Under inflation causes excessive heat build-up and internal structure damage.
- Over inflation makes it more likely for tires to be cut, punctured or broken by sudden impact.

These situations can cause a tire failure, including tread/belt separation, even at a later date, which could lead to an accident and serious personal injury or death. Consult the vehicle tire placard, certification label or the owner's manual for the recommended inflation pressures.

## NOTE

The pressure indicated on the tire sidewall is the maximum allowed in the tire, irrespective of the vehicle. Follow the vehicle manufacturer's recommendations for inflation pressure found on the vehicle tire placard, certification label or in the owner's manual.

It is impossible to determine whether radial tires are properly inflated just by looking at them. You must use a tire gauge to properly check the inflation pressure. Motorists should have their own gauge and keep it in the vehicle.

One of these tires is dangerously under inflated. You cannot tell just by looking.



Properly Inflated

50% Under Inflated

Check inflation pressure with an accurate tire gauge. A gauge calibrated in 1 psi increments up to 60 psi is sufficient for most passenger tires. A dual head gauge calibrated in 2 psi increments up to 100 psi is sufficient for light truck tires. Also, check the inflation pressures of inside tires in dual fitments, since it is imperative that these inflation pressures be checked and properly maintained because the inside dual tires are subjected to more severe operating conditions, such as:

- High heat exposure, due to close proximity to brakes
- Lower air circulation to assist in cooling
- Crowned road surfaces (which can cause inside dual tires to support more of the load than the outside dual tires)



Mechanical and Digital Style Gauges



## When to Check Inflation Pressure

Check inflation pressure when tires are cold, that is, when the vehicle has been parked for at least 3 hours or has been driven less than one mile at moderate speed. The inflation pressure in all tires, including the spare tire and inside duals, should be checked with an accurate tire gauge at least once a month. Additional checks should be made before long trips, carrying heavy loads, towing a trailer and any time high speeds are anticipated. This includes vehicles equipped with a Tire Pressure Monitoring System (TPMS). Maintaining proper inflation pressure maximizes fuel economy and optimizes overall tire performance.

Never “bleed” or reduce inflation pressure when tires are hot from driving, as it is normal for pressures to increase above recommended cold pressures. If a hot tire pressure reading is at or below recommended cold inflation pressure, it may be dangerously under inflated. In this case, immediately determine the cause and/or have the tire checked by a tire service professional.

Passenger and light truck tires may lose 1 to 2 psi inflation pressure per month under normal conditions and 1 to 2 psi for every 10 degrees F temperature drop. If a tire continually loses more than 2 psi per month, have it checked by a tire service professional. Significant changes in altitude or temperature will result in changes in inflation pressure and will require an adjustment.

## Continuous Inflation Pressure Loss

Any tire that continually requires re-inflation is a serious safety risk. The cause may be a puncture, road hazard damage, leaking valve, corroded or damaged rim, tire mounting damage or other irregular condition. Continuous use of a tire in an under inflated condition will result in heat build-up and internal tire damage. This may result in a tire failure, including tread/belt separation. Tires that continuously require re-inflation should be inspected thoroughly by a tire service professional and be properly serviced or replaced immediately.

# **WARNING**

Inflating an unsecured tire is dangerous. If it bursts, it could be hurled into the air with explosive force resulting in serious personal injury or death.

Never inflate a tire unless it is secured to a vehicle, tire mounting machine or other restraining device.

## Additional Tire Pressure Recommendations

**Dual Tire Assemblies** - For vehicles equipped with dual tire assemblies (duals), if one of the dual tires becomes significantly under inflated or flat, the other tire will carry the load for both tires, resulting in an overloaded condition for both tires. Consequently, both tires should be inspected by a tire service professional for damage.

**Tire Pressure Monitoring Systems (TPMS)** - It is still important to check inflation pressure at least once a month, even on vehicles that are equipped with a TPMS. Tire pressure monitoring systems are designed to be beneficial and accurate. However, a TPMS should not be solely relied on for inflation pressure maintenance since some systems may have limitations, such as:

- Lack of warning of low inflation pressure until one or more tires are as much as 25% below the vehicle manufacturer recommendations.
- May only detect inflation pressure differences between tires (in other words, if all tires are losing inflation pressure at the same rate, it is possible that the TPMS will not adequately warn of inflation pressure loss).
- May not warn of rapid inflation pressure loss in a single tire.

Under inflation (prior to a TPMS warning) is increasingly dangerous at high speeds, heavy vehicle loads, extended distances and at high ambient temperatures.

**Spare Tire Inflation Pressure** - Full-size and temporary spare tire inflation pressure should be checked monthly and before any long trips. Use an accurate gauge. T-type temporary spare tires require 60 psi (420 kPa). When adjusting inflation pressure in T-type tires, do so in small amounts since the tire is smaller and the pressure level changes rapidly. Do not over inflate.

**Valve Caps** - Always cover the valve stem with a sealing cap. This helps prevent moisture, dirt and other contaminants from entering the valve core, as well as providing an additional seal.

**Inflation Pressure for Off-Road Use** - Inflation pressures for tires used in most off-road situations should be the same as those for highway driving. If a lower inflation pressure is used to gain additional flotation/traction at low speeds, tires must be re-inflated before resuming driving on the highway or at higher speeds, whether on- or off- road.

**Using Nitrogen Inflation** - Nitrogen may be offered as an alternative to air for tire inflation. Nitrogen is an inert (non-flammable) gas - basically, nothing more than dry air with oxygen removed (air contains about 78% nitrogen).



For normal tire service applications, nitrogen inflation is not necessary. However, nitrogen inflation is permissible as its properties may contribute to minor reductions in inflation pressure loss. Nevertheless, several other sources of pressure leaks, such as punctures, tire/rim interface (bead), valve, valve/rim interface, and the wheel, may negate the benefit of nitrogen. Nitrogen and air can be mixed in any and all proportions. Nitrogen filled tires can and should have air added whenever nitrogen is not readily available, to maintain proper inflation as specified by the vehicle manufacturer.

**NOTE**

Whether inflated with air or nitrogen, regular inflation pressure maintenance remains critical and necessary. Use of nitrogen alone is not a replacement for regular inflation pressure maintenance.

**Proper Tire Loading**

To avoid over loading tires, maintain the proper inflation pressure and never exceed the vehicle's load capacity, gross axle weight ratings (GAWR) or the Gross Vehicle Weight Rating (GVWR) stated on the vehicle tire placard, certification label or the owner's manual. The vehicle load must also be distributed so that no individual axle, tire or dual assembly is over loaded.

The maximum load for each tire is molded on the tire sidewall (along with the maximum inflation pressure for that load). Never exceed the maximum limits on the tire or the rim/wheel.

For improved fuel efficiency, reduce vehicle weight as much as possible by removing unnecessary items from your cargo storage areas (in addition to keeping tires properly inflated).

Consult your vehicle owner's manual for load recommendations and special instructions (such as trailer towing).

**⚠ WARNING**

Under inflation and/or over loading of a tire causes excessive heat build-up and internal structural damage. This may cause a tire failure, including tread/belt separation, even at a later date, which can lead to an accident and serious personal injury or death.

Over loading a vehicle can have other serious safety consequences such as suspension or wheel failure, increased braking distance or brake failure (particularly on steep grades), and adverse vehicle handling/stability.

Consult the vehicle tire placard, certification label or owner's manual for the recommended vehicle load limits and tire inflation pressures.

# REGULAR TIRE ROTATION

## Rotation Patterns

Tire rotation procedures are established to equalize the tread wear for each tire to prolong tread life. By regularly changing a tire to another position on the vehicle, any abnormal wear patterns that were starting to develop may be corrected.

Before rotating tires, always consult the vehicle and/or tire manufacturer for specific recommendations regarding rotation. If no rotation period is specified, tires should be rotated every 5,000 to 8,000 miles (or per the tire manufacturer's recommendations) or at any sign of uneven wear. The first rotation is the most important. If tires show uneven tread wear, check for and correct any misalignment, imbalance, or other mechanical problems before rotation. Any vehicle showing a tendency for wear differential should have tires rotated more often.

Many vehicle manufacturers recommend replacing all tires on the vehicle at the same time. This makes rotation even more important for maintaining uniform tread depth and optimum tread wear of the entire set.

In the absence of vehicle manufacturer rotation recommendations, follow the rotation patterns in the figures on page 15. Note that certain types of tires cannot be rotated in the manner shown. Such tires may include directional and asymmetrical tires. Also, some vehicles may have different sized tires mounted on the front and rear axles, and these different sized tires have rotation restrictions. For these special cases, check the recommendations in the vehicle owner's manual for proper rotation.

When tires are rotated, the inflation pressures must be adjusted for the tires' new positions in accordance with the vehicle manufacturer's recommendations; refer to the vehicle tire placard, certification label or owner's manual. See "Proper Tire Inflation" on page 9.

If the vehicle has a matching full-size spare tire, it is recommended that it be included in the tire rotation. Use one of the tire rotation patterns illustrated, inserting the full-size spare at the right rear position. Always check and adjust the inflation pressure of the full size spare when incorporating it into the rotation pattern. Do not include a "Temporary Use" or T-type spare tire in any of these rotation patterns.



## Typical Rotation Patterns When Tires are the Same Size and Type

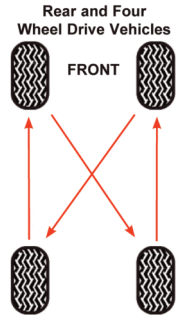
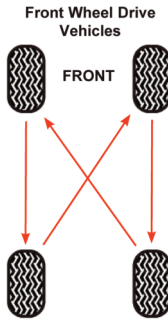
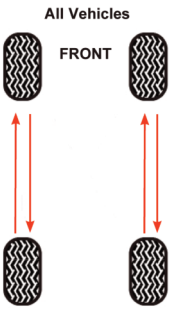
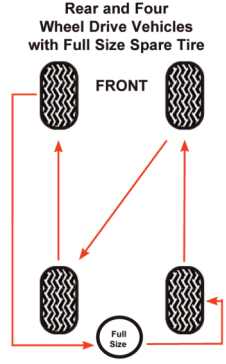
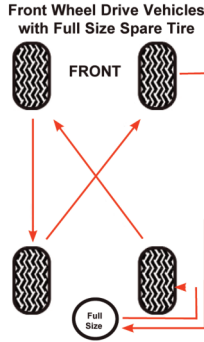
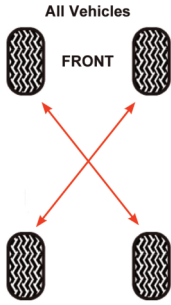

Vehicles with Dual Rear Wheels (Six-Tire Rotation)

Rear Tire Irregular Wear

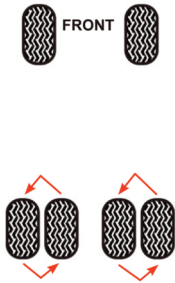

Front Tire Irregular Wear

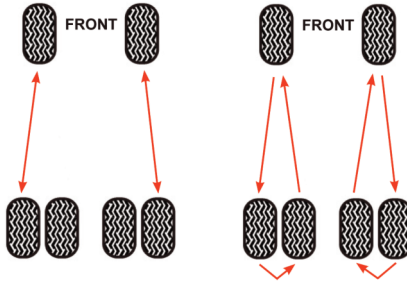

# REGULAR TIRE INSPECTION

## Tire Inspection Guidelines

In addition to maintaining proper inflation pressure, regularly inspect the tire tread and sidewalls for irregular tread wear, cracking, scrapes, bulges, cuts, snags, foreign objects or other damage resulting from use. Stones, glass, and other foreign objects embedded in the tread should be removed to prevent further damage. Even minor damage can lead to further injury and eventual tire failure. Tires with excessive cracking on the tread or sidewall(s) should be removed from service. This is typically caused by under inflation, over loading, improper storage, and/or improper long-term parking.

Consumers should check their tire tread and sidewall areas during monthly inflation pressure checks, looking for uneven or irregular tread wear or other conditions as noted above. It is recommended that tires, including the spare, be periodically inspected by a tire service professional during routine maintenance intervals such as oil changes and tire rotations.

## **WARNING**

Driving on damaged tires is dangerous. A damaged tire can suddenly fail leading to situations that may result in serious personal injury or death. Tires should be regularly inspected by a qualified tire service professional.

Replace tires when worn to 2/32" tread depth remaining anywhere on the tread face. Built-in tread wear indicators or "wear bars," which look like narrow strips of smooth rubber across the tread, will appear on the tire when the tread is worn to 2/32". When a wear bar is flush with the tread surface, the tire is worn out and it is time to replace it. If not replaced, loss of traction in adverse weather conditions is more likely to occur.



### Treadwear Indicators/Wear Bar



Based on the tread wear indicators on the tire above, the tire is worn out

In addition to wear out, if any of the following conditions below are found when inspecting a tire, rim/wheel or valve, the item should be removed from service. (Note: this list is not all-inclusive.)

- Localized spot wear
- Exposed cord or fabric material
- Unrepairable punctures
- Previous improper repairs
- Bulges, blisters
- Deep cuts/cracks
- Run flat damage
- Bent, cracked, corroded or damaged rim/wheel
- Damaged valve and/or valve core

Consult a tire service professional with any questions or concerns regarding tire, rim/wheel or valve conditions.

The "Penny Test" is an easy way to determine if your tires are worn out. The test requires a penny. Place the penny upside down into a tread groove of a tire. If part of Lincoln's head is covered by the tread, the tires have the proper amount of tread. If you can see all of Lincoln's head, it is time to replace the tire.



## Tire Service Life

It is important to have tires in good operating condition, thus tires may need to be replaced because of service conditions long before the tread is worn out. To determine if tires, including the spare, should remain in service, it is recommended that they be periodically inspected by a tire service professional during routine maintenance intervals like oil changes and tire rotations. The service life of tires includes their overall condition and vehicle usage factors, not just tread wear. All of these factors should be taken into account when considering tire replacement.

Follow the vehicle and tire manufacturer's specific recommendations, if any, regarding tire service life and replacement. In order to determine the age of the tire, look for the last four digits of the DOT tire identification number (see page 6 for identifying the week and year of manufacture).

**Tire Service Life is Not Determined by Chronological Age** - Tires are composed of various materials, including rubber, having performance properties essential to the proper functioning of the tire. These component properties evolve over a combination of time, service and storage conditions. For each individual tire, this change is affected by many elements such as temperature, storage conditions, and conditions of use (e.g., load, speed, inflation pressure, impacts and road hazard injury) to which a tire is subjected throughout its life. Since service and storage conditions vary widely, accurately predicting the service life of any specific tire based on calendar age is not possible. RMA is not aware of scientific or technical data that establishes or identifies a specific minimum or maximum service life for passenger and light truck tires. However, in some cases a tire or vehicle manufacturer may make a specific tire replacement recommendation regarding its products. If so, the consumer should consult the manufacturer with any questions with regard to following the recommendation. Furthermore, any such recommendation should not be considered a minimum service life for the tire.



## PROPER TIRE REPAIR

Tires driven even a short distance while under inflated may be damaged beyond repair. Running a tire under inflated is like running the vehicle's engine without enough oil or coolant. It may seem to work fine for a time, but serious permanent damage has occurred. Adding oil or coolant won't repair engine damage, and adding inflation pressure won't fix tire damage. The tire will remain seriously damaged and can still fail, even after inflation pressure is corrected.

### Have Your Tire Repaired Properly

Proper tire repairs should be performed by trained tire service professionals using RMA or tire manufacturer approved procedures. If a tire continually loses inflation pressure or has lost all or most of its inflation pressure, it must be removed from the wheel for a complete internal inspection to check for damage. For vehicles equipped with dual tire assemblies (duals), if one of the dual tires becomes significantly under inflated or flat, the other tire will carry the load for both tires, resulting in an overloaded condition for both tires. Consequently, both tires should be inspected by a tire service professional for damage.

Never have a tire repaired with an injury that is greater than  $\frac{1}{4}$  inch in diameter. Do not repair an injury outside the puncture repair area.

## WARNING

Improperly repaired tires can fail while in service, such as by tread/belt separation, which can lead to an accident and serious personal injury or death.

Tires must always be properly repaired as described in the RMA wall chart, "Puncture Repair Procedures for Passenger and Light Truck Tires."



*Puncture repairs are limited to the tread area as generally depicted above.*

The basic principles for proper puncture repair:

- Remove the tire from the wheel for inspection and repair. Some damage to the tire may only be evident on the tire interior.
- Fill the injury with a suitable vulcanizing material or rubber stem that must fill the injury and keep moisture out.
- Seal the inner liner with a patch to prevent loss of inflation and keep moisture out.

Not all tires can be repaired. In addition to the RMA puncture repair procedures, there may be additional limitations based on individual tire manufacturer repair policies. These may include the type of service such as speed rating, load index, run-flat technology and commercial application.

When having a tire repaired, make sure the tire service professional:

- Never performs a tire repair on-the-wheel
- Never uses only a plug (stem)
- Never uses only a patch

### **Vehicle Original Equipment Temporary Tire Mobility Kits**

A temporary tire mobility kit may be supplied by the vehicle manufacturer as an alternative to a spare or runflat tire in passenger car and light truck applications. The temporary tire mobility kit is normally comprised of a puncture sealant and a small air compressor or container of propellant.

Use of a temporary tire mobility kit:

- Is not considered a repair to the tire
- Only provides a temporary solution to promptly reach a service location for professional inspection and possible repair of the affected tire. Refer to tire manufacturer for specific guidelines regarding repairability and warranty.

End-users of temporary tire mobility kits supplied as original equipment in a passenger car or a light truck vehicle should always follow all instructions provided by the vehicle manufacturer, including limits on the amount of driving at reduced speeds allowed to safely reach a tire service location.



## Aftermarket Sealants

The RMA does not endorse aftermarket sealant products. Aerosol, liquid, gel or other substances injected into a tire through the valve are not considered proper repairs. Such products:

- may be flammable and potentially explosive
- may damage the tire
- may void the tire manufacturer's warranty
- may interfere with or damage tire pressure monitoring system sensors

Consult the tire manufacturer's service recommendations and warranty policy.

Flammable propellants and/or liquids in aftermarket sealants or aerosol inflators may cause a tire to explode under certain circumstances. Never introduce a flammable substance into a tire. Inform the tire service professional if you have used any aftermarket product to seal or inflate a tire.

# VEHICLE CONDITION, ALIGNMENT AND MAINTENANCE

There is a close relationship between several mechanical systems on a vehicle and its tires. Tires, wheels, brakes, shock absorbers, drive train, steering and suspension systems, among others, must all function together to perform safely and comfortably and to give optimum tread wear. Improper or inadequate vehicle maintenance can cause tires to wear rapidly and/or abnormally.

## Abnormal Mechanical Conditions

**Improper Tire Inflation** - For optimum service, use the inflation pressures specified by the vehicle manufacturer on the vehicle tire placard, certification label or owner's manual. Under inflation may result in rapid and/or abnormal tread wear, improper vehicle handling and decreased fuel economy. Over inflation can result in rapid and/or abnormal tread wear, decreased traction and premature wear of suspension components. See page 9

**Vehicle Wheel Misalignment** - If the vehicle wheels are not properly aligned, tires will experience stresses as if they were constantly cornering. This will cause increased and abnormal tread wear. A qualified mechanic should correct misalignment of wheels. Front-wheel drive vehicles and those with independent rear suspension require special attention with alignment of all four wheels.

**Lack of Tire Rotation** - Tire rotation procedures are established to equalize the tread wear for each tire to prolong tread life. By regularly changing a tire to another position on the vehicle, any abnormal wear patterns that were starting to develop may be corrected (see "Tire Rotation" on page 14).

**Tire and Wheel Assembly Out-of-Balance** - A tire and wheel assembly that is out-of-balance can cause abnormal tread wear due to vibration and irregular road contact which may be worse at specific speeds.

**Damaged Wheels** - In addition to resulting in possible loss of inflation, damaged wheels can cause a tire to contact the road unevenly and cause abnormal tread wear. Wheel damage may not be visually obvious and should be checked by a tire service professional using proper measuring equipment.

**Brakes in Disrepair** - If not in proper working order, brakes can grab unevenly and cause abnormal tread wear.

**Worn Struts, Shock Absorbers** - A worn strut or shock absorber will not properly dampen vehicle motion and cause abnormal tread wear.

**Worn or Loose Suspension and Steering Systems** - Excessive wear and looseness anywhere in the suspension and steering systems (such as tie-rod ends and ball joints) can cause tire and wheel assemblies to move in ways in which they were not designed, resulting in abnormal tread wear.



### Additional Conditions Affecting Tread Wear

Tread wear is affected by many different vehicle operating conditions. Abnormal wear typically results from a combination of unsatisfactory conditions and may make an accurate diagnosis of the cause(s) difficult. It is important to identify the emergence of abnormal wear in its early stage and correct the cause before valuable tire tread wear is lost. Most of the causes of abnormal tread wear can be corrected. The causes can include excessive tire stresses due to driving habits, road surfaces, terrain and axle position.

**Driving Habits** - The way a vehicle is driven has a great deal to do with tread wear and safety. Observe posted speed limits and avoid hard stops, starts and cornering. In addition, avoid potholes, objects on the road, and curbs (such as hitting/forcing the tire against the curb when parking). The rate of tread wear increases during hard cornering at both high and low speeds due to scuffing caused by lateral forces, particularly on the front tires. Hard acceleration or braking will also cause increased tread wear due to torque and weight transfer. Typically the front tires are carrying a greater load and are doing the most braking.

**Road Surfaces/Terrain** - Rapid or abnormal tread wear may be caused by abrasive road surfaces such as those with sharp or coarse highway paving materials. Areas that have numerous hills or curves can also lead to accelerated tread wear.

**Axle Position** - The position of a tire on a vehicle determines what stresses the tire will experience. The tires on the drive axle are affected by acceleration. Depending on the vehicle, this can be the rear axle, the front axle or, in the case of four-wheel drive, both axles. On front-wheel drive vehicles, the front axle also steers the vehicle and performs most of the braking. Free-rolling, rear tires may also experience some abnormal tread wear. Rotating tires on the vehicle may help to minimize abnormal tread wear.



## Spare Tire Maintenance

Spare tire (full-size and temporary spare) inflation pressure should be checked monthly and before any long trips. Use an accurate gauge. T-type temporary spare tires require 60 psi (420 kPa). When adjusting inflation pressure in T-type tires, do so in small amounts since the tire is smaller and the pressure level changes rapidly. Do not over inflate.

Inspect the spare tire/rim/wheel periodically (i.e. during tire rotation intervals) for any visible damage to the tire or corrosion on the wheel.

If the vehicle has a matching full-size spare tire, it is recommended that it be included in the tire rotation. Always check and adjust the inflation pressure of the full size spare when incorporating it into the rotation pattern.

There may be restrictions on speed, mileage and placement of a temporary spare tire. Consult the vehicle owner's manual for use of a temporary spare tire.

### CAUTION

T-type temporary spare tires should only be used with rims/wheels specifically intended for them.

Rims/wheels intended for use with T-type tires should not be used with any other types of tires.

A temporary spare tire and wheel assembly should never be used on a vehicle with which it is not compatible. Never use more than one temporary spare tire at a time.

## Tire Storage Recommendations

Stored tires should be protected against environmental effects such as sunlight, high heat, ozone and other potentially damaging conditions. Weather checking/ozone cracking can occur during direct and extended exposure to damaging effects of the environment, such as ozone and heat from sunlight. Ozone cracking can also be caused by exposure to electric motors, welding equipment, or other ozone generating sources. Tires with severe weather checking/ozone cracking or any cracking that extends to the tire casing cords/plies should be removed from service.



- Store tires where the area is clean, dry and well ventilated, but with a minimum of circulating air.
- Store tires in an area with temperate ambient conditions (mild temperatures, shaded or dark).
- Store tires raised off a storage area's floor surface to minimize exposure to moisture or damage.
- Avoid contact with petroleum-based products and/or other volatile solvents or substances.
- Store tires away from electric motors, battery chargers, generators, welding equipment or other ozone generating sources.

Indoor storage is recommended, however if tires must be stored outdoors:

- Store tires where they are raised off the ground (or on storage racks) and not in contact with heat absorbent surfaces.
- Protect tires with an opaque, waterproof covering with some type of vent openings to avoid creating a "heat box" or "steam bath" effect.

**Tires mounted on a stored vehicle** - Store the vehicle such that all weight is removed from the tires. If vehicle weight cannot be removed, unload the vehicle to minimize the weight. Maintain the recommended tire inflation pressure, including the spare. The surface where the vehicle is parked/stored should be firm, reasonably level, well drained and clean. Vehicle should be moved every three (3) months so the tire flex area is changed.

**Returning tires from storage back to service** - Before placing stored tires back into service, a tire service professional should conduct a visual and tactile inspection to be sure each tire is clean, dry, free of foreign objects, and/or does not show signs of damage. See Tire Inspection Guidelines on page 16. Once mounted on a rim/wheel, the tire (including the spare tire) should be inflated to the recommended inflation pressure. See Proper Tire Inflation on page 9.

### **Cleaning Tires**

Clean tires with soap and water and a soft bristle brush or a shop cloth. Treating tires with incompatible dressings or harsh cleaning agents will hasten oxidation and result in premature cracking. Never use petroleum-based tire dressings, cleaners or other products. Use of a pressure washer or steam cleaner may be damaging to the tire. Contact the tire manufacturer for specific recommendations on cleaning tires.

## GOOD DRIVING HABITS

The way you drive has a great deal to do with your tire service life and safety. Therefore, in addition to proper tire maintenance, cultivate good driving habits for your own benefit.

- Observe posted speed limits.
- Avoid fast starts, stops and turns.
- Avoid potholes and objects on the road.
- Do not run over curbs or hit the tire against the curb when parking.

The rate of wear increases during hard cornering at both high and low speeds due to scuffing caused by lateral forces, particularly on the front tires. Hard acceleration or braking will also cause increased wear due to torque and weight transfer.

### Road Hazard and Impact Damage

Punctures, cuts, snags, and other issues can lead to further damage if not repaired in time. The tire must be demounted and carefully inspected to determine whether it is repairable. Some road hazard damage may result in gradual inflation pressure loss. If not corrected as soon as possible, such damage can ruin tires that could otherwise have been repaired. For information on proper tire repair, see page 19.

## WARNING

Driving on damaged tires is dangerous. A damaged tire can suddenly fail leading to situations that may result in serious personal injury or death. Tires should be regularly inspected by a qualified tire service professional.

Impact damage to the tire may initially show little or no exterior evidence. However, internal damage can progress with additional mileage and eventually cause internal tire separation, detachment or sudden loss of inflation. Impact damage may cause gradual inflation pressure loss. After experiencing an unusual impact, have the tire inspected by a tire service professional.

A rim bruise break (pinch shock) occurs when the tire strikes a rigid object (like a curb or pothole) hard enough to crush the tire's sidewall between the rim flange and the rigid object. Vehicles operated off-road or in areas away from paved roads can encounter many objects that can cause tire damage. Careful inspection of the tires should be made after use in off-road service.



### Sudden Vibration or Ride Disturbance

If the vehicle experiences a sudden vibration or ride disturbance and/or there is a possibility the tires and/or vehicle have been damaged, gradually reduce speed. Do not abruptly brake or turn. Drive with caution until you can safely pull off the road. Stop and inspect the tire. If the tire is under inflated or damaged, deflate and replace it with the spare tire. If a cause cannot be detected, the vehicle should be towed to the nearest vehicle or tire dealer for an inspection.

### Tire Spinning

The centrifugal forces created by a rapidly spinning tire can cause an explosion by literally tearing the tire apart. These forces act on the complete tire structure, and can be of such magnitude as to break the beads in addition to rupturing the tire. Some vehicles are able to bring a tire to its centrifugal force failing point in just 3 to 5 seconds.

## WARNING

Excessive speed in a free-spinning tire can cause the tire to explode from extreme centrifugal force. The energy released by such an explosion is sufficient to cause serious physical injury or death.

Never spin a tire above a speedometer reading of 35 mph (56 km/h). Never stand near a spinning tire.



When stuck on ice, snow, mud, or wet grass, the vehicle should be rocked gently (alternately using forward and reverse gears) with the least amount of wheel spinning. Repeatedly shift the gear lever from drive to reverse on automatic transmissions or reverse to second on manual transmissions, while applying gentle pressure to the accelerator. Vehicles with ABS or traction control systems may have specific instructions in their owner's manual.

### Wet Weather Driving

Driving too fast on wet roads, through standing water or in the rain, can cause your tires to hydroplane. This means that your tires travel on a film of water rather than contacting the road. After a dry spell, rain can further reduce traction from oil and other substances that have collected on the roadway. In addition, leaves can hide moisture on a road surface, even long after the rain has stopped. When roads are wet, slow down and drive carefully.

## Winter/Snow Conditions

Every time the outside temperature drops 10 degrees Fahrenheit, the inflation pressure inside your tires goes down about 1 to 2 psi. Never reduce tire pressures in an attempt to increase traction on snow or ice. It does not work and your tires will be more susceptible to damage from under inflation. In snowy areas, many cities and counties have “snow emergency” regulations which are invoked during heavy snowfalls. Check with authorities for the rules in your area. Under some rules, motorists are subject to fines if they block traffic and do not have snow tires on their vehicles. Slow down and drive carefully in all winter conditions.

**Mountain-Snowflake Symbol** - Tires designed for use in severe snow conditions generally have tread patterns, structure and materials to give superior performance. These tires are marked with the “M+S” designation plus a mountain/snowflake symbol.



**Winter/Snow Tire Application** - It is always preferable to apply winter/snow tires to all wheel positions, including duals, to maintain vehicle mobility and control.

- If winter/snow tires are applied to the front axle of a vehicle, winter/snow tires must also be installed on the rear axle. Do not apply winter/snow tires only to the front axle. This applies to all passenger and light truck vehicles including front-wheel-drive, 4WD, and AWD vehicles.
- If winter/snow tires are installed on the rear axle of any vehicle, it is recommended (but not required) that they also be installed on the front axle.

**Studded Winter/Snow Tire Application** - Studded winter/snow tires have higher traction qualities under most winter weather conditions.

- If studded winter/snow tires are installed on the front axle of any vehicle, studded winter/snow tires must also be installed on the rear axle. Do not apply studded winter/snow tires only to the front axle.
- If studded winter/snow tires are installed on the rear axle of any vehicle, it is strongly recommended that they should also be installed on the front axle. Only if studded winter/snow tires are installed on all wheel positions of a vehicle will optimum handling characteristics be achieved.
- Some states prohibit the use of studded tires and many states have seasonal limitations on their use. Before installing, check with state and local regulations.

It is generally acceptable to apply a winter/snow tire with a lower speed rating than the OE tire; however, the vehicle speed is to be restricted to that of the replacement tire.



## **WARNING**

Installing winter/snow tires (studded or unstudded) only on the front axle may cause the vehicle to experience adverse handling characteristics. This may result in an accident, which could cause serious injury or death.

**Chains** - Make sure chains are the proper size and type for your tires, otherwise they may damage the tire sidewall and cause tire failure. If you have dual tires on your vehicle, particular care must be taken to assure adequate clearance between loaded tires to avoid damage from chains. Consult a tire service professional for proper application.

# TIRE REPLACEMENT GUIDELINES

## The Right Tire for the Vehicle

When tires need to be replaced, do not guess what tire is right for the vehicle. For the answer, refer to the vehicle tire placard and/or certification label, usually located on the vehicle door edge, door post, glove box or fuel door. Also, check the vehicle owner's manual for any additional tire replacement recommendations. The vehicle tire placard identifies the size of the tires, including the spare, that were installed on the vehicle as original equipment (OE). The placard also specifies the recommended cold inflation pressures for the tires on the front/rear axles and for the spare. If the vehicle does not have a vehicle tire placard or certification label, consult the vehicle owner's manual, vehicle manufacturer, or tire manufacturer.

## NOTE

Before replacing tires, ALWAYS refer to and follow the vehicle manufacturer's tire replacement recommendations and restrictions.

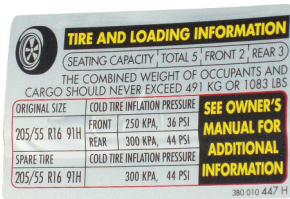

EXAMPLE OF A  
VEHICLE TIRE PLACARD

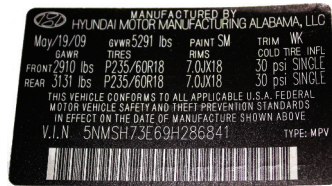

EXAMPLE OF A  
VEHICLE CERTIFICATION LABEL

Replacement tires should be the same as the OE size designation, or approved options, as recommended by the vehicle or tire manufacturer. Never choose a replacement tire of a smaller tire size or with less load-carrying capacity than the OE tire size at the specified vehicle placard pressure. It is recommended that all four tires be of the same size, speed rating, and construction (radial, non-radial). In some cases, the vehicle manufacturer may require different sized tires for either the front or rear axles.

Selecting a tire or rim/wheel other than that recommended by the vehicle manufacturer is a complex process that requires extensive knowledge and training. Consult a tire service professional.



## Self-Supporting Runflat Tires

Runflat tires have specific servicing requirements, such as product-specific puncture repair or demounting/mounting procedures, which vary by vehicle and tire manufacturer. Consult with the tire manufacturers for details. A functioning tire pressure monitoring system (TPMS) must be used with runflat tires. Never mix runflat tires with conventional tires unless in an emergency situation on a limited, temporary basis.

## Tire Mixing

- It is recommended that all four tires be of the same size, load index, speed rating, and construction (radial, non-radial). In some cases the vehicle manufacturer may require different sized tires for either the front or rear axles.
- Speed rated tire - If the vehicle tire placard and/or owner's manual specifies speed rated tires, the replacement tires must have the same or higher speed rating to maintain vehicle speed capability. Tire speed ratings do not imply that vehicles can be safely driven at the maximum speed for which the tire is rated, particularly under adverse road and weather conditions, or if the vehicle has unusual characteristics. Never operate a vehicle in an unsafe or unlawful manner.

If replacement tires have lower speed capability than specified by the vehicle manufacturer, the vehicle's speed must be restricted to that of the replacement tire. Also, vehicle handling could be affected. Consult the vehicle manufacturer or the tire manufacturer for recommendations.

- Four-wheel drive (4WD) and all-wheel drive (AWD) vehicles - If no instructions for tire mixing appear in the vehicle owner's manual, follow these guidelines:
  - DO NOT mix tire sizes. All four tires must be marked with the same tire size, unless otherwise specified by the vehicle manufacturer. This also applies to winter/snow tires.
  - DO NOT mix radial and non-radial tires. All four must be either radial or non-radial.
  - DO NOT mix tread pattern types such as all-terrain and all-season.

For use of winter tires, see page 28.

## Replacing Less Than Four Tires

When replacing tires on a vehicle, it is recommended and preferred that all four tires be replaced at the same time for continued optimal vehicle performance. However, for those cases where this is not feasible, below are some general guidelines to consider when replacing less than four tires for a light vehicle, whether it is one or two tires.

**Replacing Two (2) Tires** - When a pair of replacement tires is selected in the same size and construction as those on the vehicle, the two newer tires should be installed on the rear axle. Generally, new tires with deeper tread will provide better grip and evacuate water more effectively, which is important as a driver approaches hydroplaning situations. Placing greater traction on the rear axle on wet surfaces is necessary to prevent a possible oversteer condition and loss of vehicle stability.

### NOTE

In some cases, the vehicle manufacturer may specifically advise against replacing less than all four tires. Always check and follow the recommendations in the vehicle owner's manual. For 4WD and AWD vehicles, even small differences in outside diameter may cause drive-train damage or mechanical malfunction.

**Replacing One (1) Tire** - Replacing a single tire on a vehicle can have an adverse effect on suspension systems, gear ratios, transmission, and tire tread wear. If single tire replacement is unavoidable, it is recommended that the single new tire be paired with the tire that has the deepest tread and both be placed on the rear axle. Placing greater traction on the rear axle on wet surfaces is necessary to prevent a possible oversteer condition and loss of vehicle stability.

## Used Tires

This information pertains to used passenger and light truck tires installed as replacement tires or as equipped on a used vehicle.

## WARNING

Driving on damaged tires is dangerous. A damaged tire can suddenly fail leading to situations that may result in serious personal injury or death. Tires should be regularly inspected by a qualified tire service professional.



Once tires are applied to a vehicle and put into service (this includes spare tires), they are considered “used.” There is a potential risk associated with the installation of used tires that have uncertain or unknown history of use, maintenance or storage conditions. Such tires may have damage that could eventually lead to tire failure.

Not all tire damage that can lead to tire failure is outwardly visible. For instance, improper repairs or damage to a tire’s inner liner can only be observed by inspecting the inside of the tire, demounted from the wheel. A qualified tire service professional should inspect the internal and external condition of a used tire prior to application. In the case of a used vehicle purchased by a consumer, the only way to determine the condition of its tires is to have them demounted by a tire service professional for the same type of inspection.



Rubber Manufacturers Association • 1400 K Street, NW, Suite 900 • Washington, DC 20005  
[www.rma.org](http://www.rma.org)

© 2013 Rubber Manufacturers Association